

CITATION BAR



OWNER'S MANUAL

/ IMPORTANT SAFETY INSTRUCTIONS

Do Not Use Extension Cords

To avoid safety hazards, use only the power cord supplied with this product. We do not recommend that extension cords be used with this product. As with all electrical devices, do not run power cords under rugs or carpets, or place heavy objects on them. Damaged power cords should be replaced immediately by an authorized service center with a cord that meets factory specifications.

Handle the AC Power Cord Gently

When disconnecting the power cord from an AC outlet, always pull the plug; never pull the cord. If you do not intend to use your speaker for any considerable length of time, disconnect the plug from the AC outlet.

Do Not Open the Cabinet

There are no user-serviceable components inside this product. Opening the cabinet may present a shock hazard, and any modification to the product will void your warranty. If water accidentally falls inside this product, disconnect it from the AC power source immediately, and consult an authorized service center.

/ TABLE OF CONTENTS

IMPORTANT SAFETY INSTRUCTIONS.....	2
INTRODUCTION	4
WHAT'S IN THE BOX.....	5
PRODUCT OVERVIEW.....	7
INSTALLATION	11
CONNECTING TO TV.....	14
CONNECTING TO OTHER DEVICES	16
POWER ON	18
CONNECTING TO INTERNET	19
SPEAKER SETUP (OPTIONAL).....	21
USING YOUR CITATION BAR	23
SOUND SETTINGS.....	29
SETTINGS	30
SPECIFICATIONS.....	32
TROUBLESHOOTING.....	33
TRADEMARKS	35

/ INTRODUCTION

This manual includes information on the CITATION BAR (soundbar). We encourage you to take a few minutes to read this manual, which describes the products and includes step-by-step instructions to help you set up and get started. Read and understand all the safety instructions before using your product.

This product may have an important software update available. Please follow the instructions to connect the product to Wi-Fi to ensure that your product has the most recent software updates.

Design and specifications are subject to change without notice.

If you have any questions about these products, their installation or their operation, please contact your Harman Kardon retailer or customer service, or visit us at www.harmankardon.com

/ WHAT'S IN THE BOX

Carefully unpack the box and check if the following parts are included. If any part is damaged, do not use it, contact your Harman Kardon retailer or customer service.



1

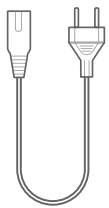

2

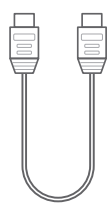

3

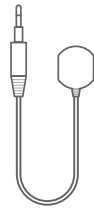

4



5

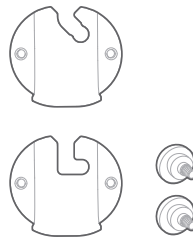

6

1. Main unit
2. Power cord
3. HDMI cable
4. Infrared (IR) repeater
5. Remote control (with 2 AAA batteries)
6. Wall-mount brackets

Inserting batteries before using the remote control (AAA batteries x 2)

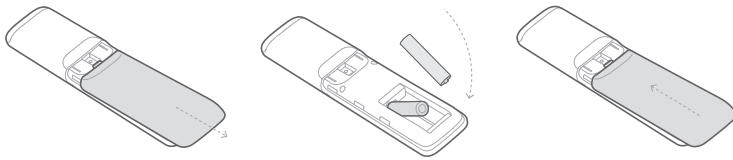







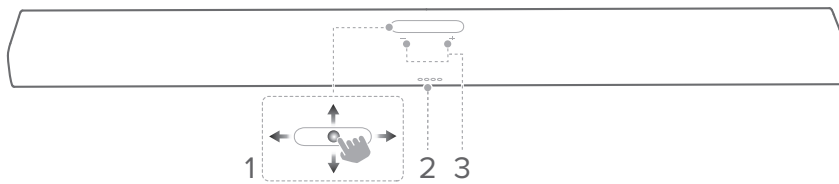

Slide the battery cover in the direction of the arrow until it is completely removed. Insert 2 AAA batteries (1.5V) oriented so that their polarity is correct. Slide the battery cover back into position.

PRODUCT OVERVIEW

Front Panel & Top Panel







1. Touch screen (Swipe up / down / left / right to find out more)

	Wi-Fi signal indicator.
	Press to mute or unmute the microphone.
	Push to talk to Xiaowei Voice Assistant.
	Press to select a source (Bluetooth / Aux / HDMI / Optical).
	Press to customize the audio settings.
	Press to customize the general settings.
	Press to set up multi-channel surround sound system with your CITATION SUB or CITATION SURROUND. (Optional)
	Press to check the system information of this product.

2. LED indicators

- Light on when active.
- Xiaowei status indicators:

	Activated
	Listening
	Responding
	Microphone muted

3. - / + (Volume)

- Press to decrease or increase the volume.
- Press both simultaneously to mute the soundbar audio.

Back Panel

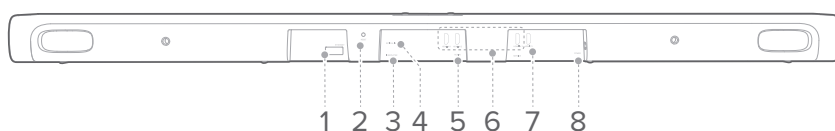

1. ETHERNET

- Connect to the Internet (RJ45 connector).

2. RESET

- Press and hold for 5 seconds to restore the factory settings.

3. IR REPEATER

- Connect to the infrared (IR) repeater to extend the remote control range.

4. OPTICAL IN

- Connect to an optical audio output on your TV or a digital device.

5. AUX IN

- Connect to an audio device (3.5mm jack).

6. HDMI 1 / HDMI 2 / HDMI 3

- Connect to the HDMI output on a digital device.

7. HDMI ARC (TV OUT)

- Connect to the HDMI (ARC) input on your TV.

8. POWER

- Connect to the power supply.

Remote Control

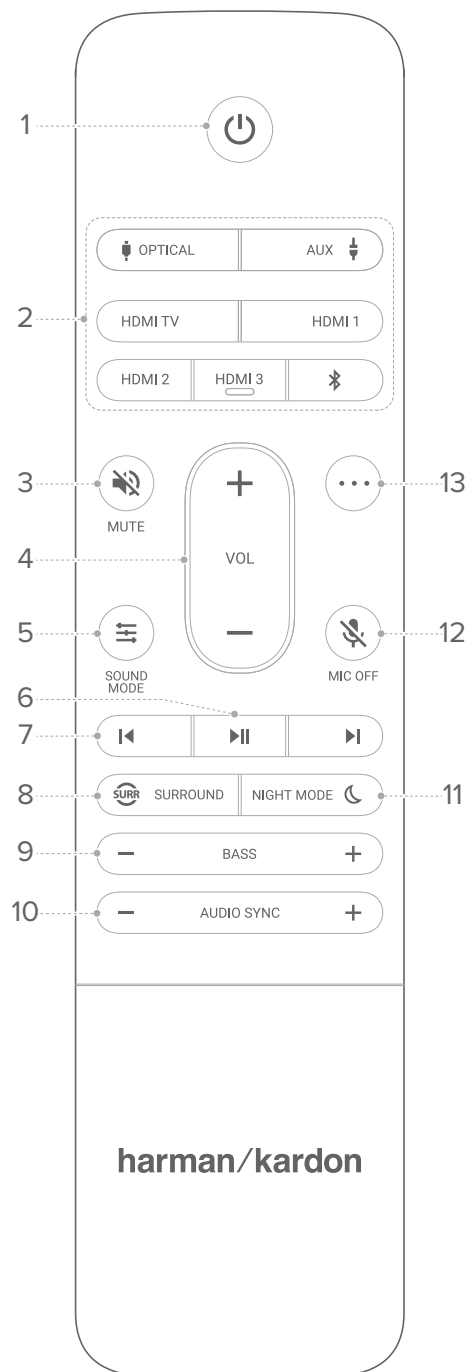

1. **⏻ (Power)**
 - Power on or switch to standby.
2. **Source zone**
 - Select an input source for the soundbar: **OPTICAL / AUX / HDMI TV / HDMI 1 / HDMI 2 / HDMI 3 / Bluetooth.**
 - Press **🔗** to pair with a new device.
3. **🔇 MUTE**
 - Mute or unmute the soundbar audio.
4. **4. VOL + / -**
 - Increase or decrease the volume level.
5. **🔊 SOUND MODE**
 - Select preset sound modes to suit your music or video: Music / Movie / News / Standard.
6. **▶▶**
 - Play or pause QQ music or Bluetooth playback.
7. **⏮ / ⏭**
 - Skip to the previous or next track for QQ music or Bluetooth playback.
8. **🌀 SURROUND**
 - Turn the surround sound effect on or off (for a standalone soundbar).

9. BASS - / +

- Decrease or increase the bass level of the soundbar (or the optional subwoofer when successfully paired).

10. AUDIO SYNC - / +

- Decrease or increase audio sync delay if the video and audio synchronization is not correct.

11. NIGHT MODE 

- Turn the night mode (Dynamic Range Control) on or off for Dolby Digital and DTS tracks.

12.  MIC OFF

- Turn the microphone on the soundbar on or off.

13. . . .

- Push to talk to Xiaowei Voice Assistant.

/ INSTALLATION

Placement

NOTES:

- To avoid wireless interference, keep a minimum distance of 5 meters (16.4 feet) between other wireless devices and the soundbar.
 - Make sure that there is a live AC (mains) outlet nearby.
 - Do not place the soundbar on its front, back or top when in use.
 - Do not place any objects on top of the soundbar.
- 1) Place the soundbar on its rubber feet on a stable and level surface below your TV.
 - 2) If the soundbar blocks the infrared sensor on your TV, plug the IR repeater into the **IR REPEATER** connector on the back of the soundbar, and then peel off the sticker and attach in between the soundbar and the TV.

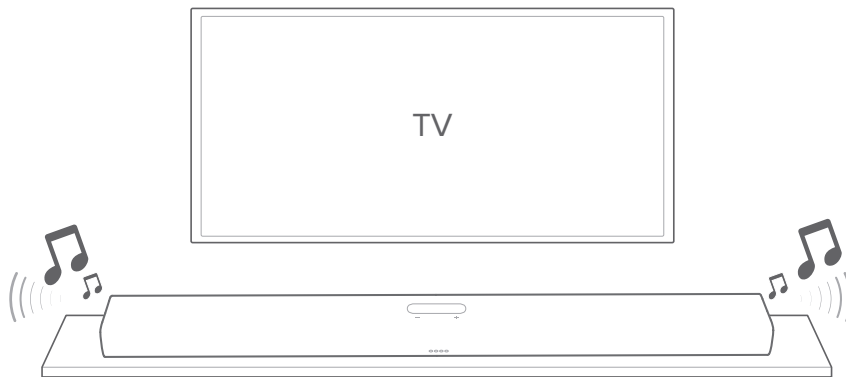

Wall-mount

NOTES:

- Before mounting on a wall, make sure the wall can support the weight of this product.
 - For the wall mounting, avoid a location with high temperature or humidity. Install on a vertical wall only.
 - Connect cables from the product to external devices before mounting on the wall.
 - Before moving or installing the product, make sure to power off and unplug first. Otherwise, it may cause an electric shock.
 - Do not connect the power cord of the soundbar or your TV to a live AC (mains) outlet until all connections between components are complete.
 - Leave a clearance of at least 5 cm (1.9 in) between the top of the soundbar and the bottom of the TV.
- 1) Use tape to stick the wall-mounted paper guide on the wall, push a pen tip through the center to mark the wall-mounted bracket location and remove the paper.

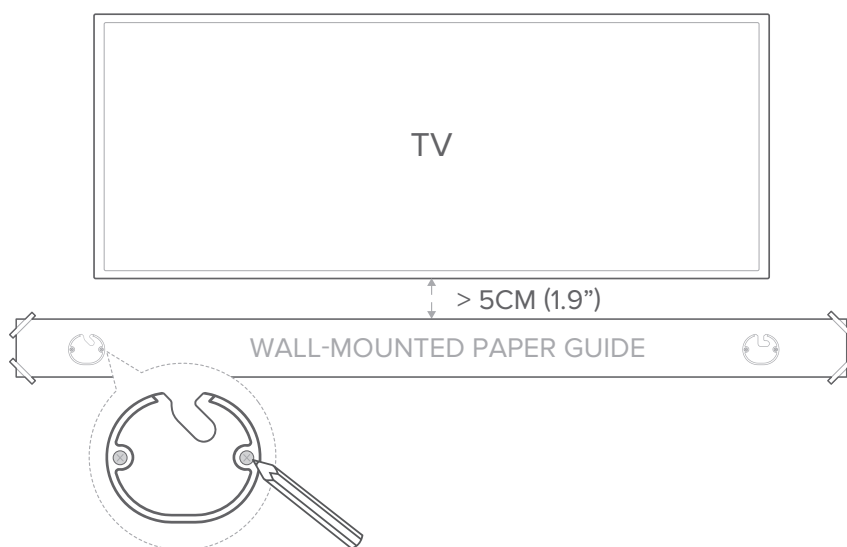

- 2) Screw the wall-mount brackets on the pen mark; screw the threaded mounting post into the back of the soundbar, then hook the soundbar on the wall.

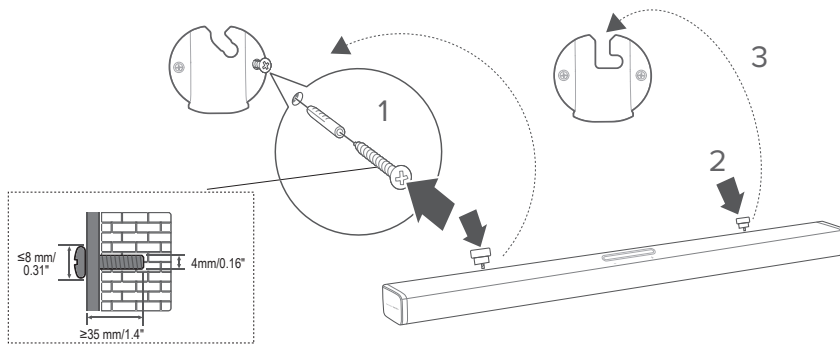

/ CONNECTING TO TV

NOTES:

- If you want to enjoy sound only from the soundbar, make sure to set your TV audio settings to support external speakers and disable the built-in TV speakers.
- Before you make or change any connections, make sure that all devices are disconnected from the power outlet.

HDMI (Preferred)

- 1) Connect the supplied HDMI cable from the **HDMI TV** connector on the back of the soundbar to the **HDMI IN (ARC)** connector on your TV.
- 2) Press  **HDMI ARC** on the touch screen or press the **HDMI TV** button on the remote control to select the **TV ARC** mode.

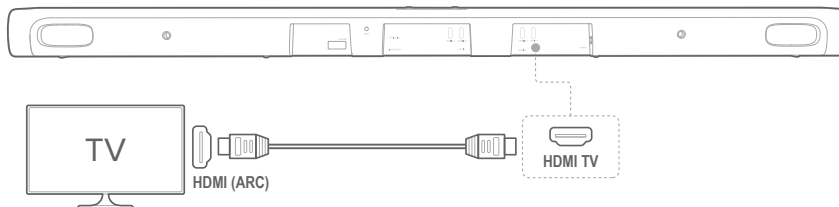

NOTES:

- An HDMI connection supports digital audio and video with a single connector. It is the best option to connect to your soundbar.
- If your TV features an HDMI ARC connector, you can enjoy the TV audio through your soundbar by using a single HDMI cable.
- This HDMI connection is required if you intend to connect other video devices to the soundbar inputs to display on your TV.
- On your TV, turn on HDMI-CEC operations. HDMI-CEC is a feature that enables CEC compliant devices that are connected through HDMI to be controlled by a single remote control, such as volume control for both the TV and the soundbar. See the user manual of your TV for details.

Optical

NOTE:

- Make sure you have removed the protective cap from both ends of the optical cable.
- 1) Connect the **OPTICAL IN** connector on the soundbar to the **OPTICAL OUT** connector of your TV with an optical cable (sold separately).
 - 2) Press **OPTICAL IN** on the touch screen or press the **OPTICAL** button on the remote control to select the **OPTICAL** mode.

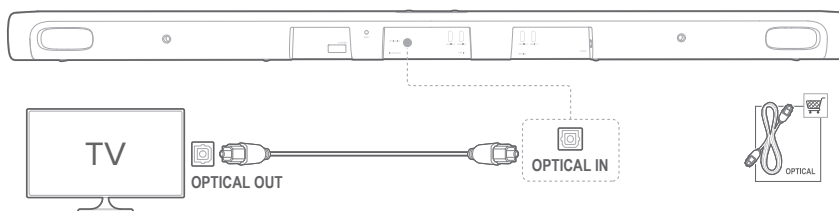

CONNECTING TO OTHER DEVICES

HDMI (Preferred)

Connect a digital device such as a set-top box, DVD/Blu-ray player, or games console to your soundbar through a single HDMI connection.

- 1) Connect the HDMI cable from the **HDMI IN** connector on the back of the soundbar to the **HDMI OUT** connector on your digital device.
- 2) Press  **HDMI 1 / HDMI 2 / HDMI 3** on the touch screen or press the **HDMI 1 / HDMI 2 / HDMI 3** button on the remote control to select the **HDMI** mode.

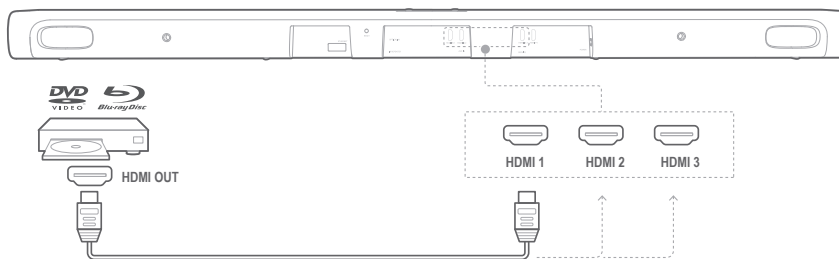

NOTE:

- For the best performance, always use a High-Speed (type 2) HDMI cable. See your HDMI cable specifications for more details.

Optical or Analogue

- 1) Connect the **OPTICAL IN** or **AUX IN** connector on the soundbar to the **OPTICAL OUT** or **AUDIO OUT** jack of the source device by using an optical cable (sold separately) or 3.5mm audio cable (sold separately).
- 2) Press **OPTICAL IN** or **AUX** on the touch screen or press the **OPTICAL** or **AUX** button on the remote control to select the **OPTICAL** or **AUX** mode.

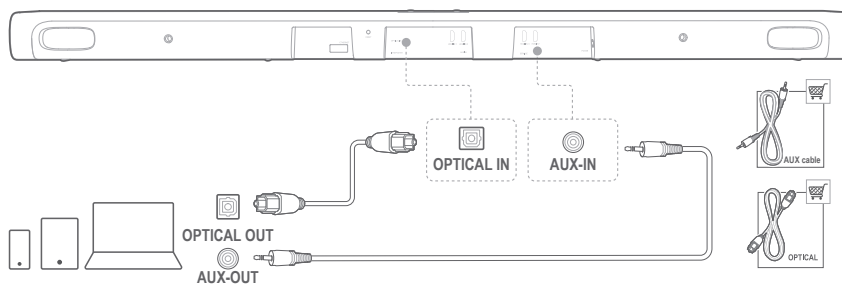

/ POWER ON

NOTES:

- Use the provided power cord only.
- Before connecting the power cord, make sure all other connections have been completed.
- When you disconnect the power cord, always pull the plug, never the cable.
- Do not connect this product or other components to an AC outlet until all connections between components are complete.

- 1) Plug one end of the AC power cord into the **POWER** connector on the back of the soundbar.
- 2) Plug the other end of the power cord into a live AC (mains) outlet. The soundbar will automatically power on and the touch screen will turn on. Alternatively, press **⏻** on the remote control to power on or switch to standby.

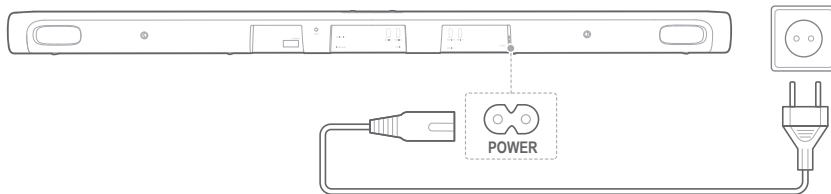

- 3) Select your language as instructed on the touch screen for the first-time setting.

/ CONNECTING TO INTERNET

Your CITATION BAR is required to connect to the Internet (Wi-Fi or Ethernet) with the HK Citation / Surround app.

NOTES:

- If you want to use the Internet with Ethernet, make sure to connect the Ethernet cable before plugging in the power cord.
- If you encounter any setup issues, make sure to enable Bluetooth and location services on your smartphone or tablet.
- Make sure that your Citation speaker is connected to the same wireless network as your smartphone or tablet.
- Once this product is connected to the Internet, it will receive a periodic over-the-air software update to improve performance. This update may take a few minutes to complete.

- 1) Scan the QR code below or search “**HK Citation / Surround**” from the AppStore (for iOS devices) or from 百度手机助手 (for Android devices) and download it.

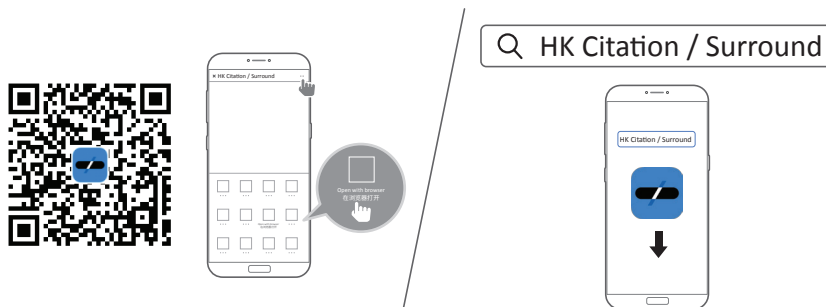

- 2) Power on your CITATION BAR.
- 3) Run the HK Citation / Surround app and set up your CITATION BAR as instructed in the app. Always follow the instructions in the app to complete the Wi-Fi setup. You can associate CITATION BAR with  Xiaowei during or after the first-time setup (See "Talk to Voice Assistant" in the chapter "USING YOUR CITATION BAR").

* To avoid any interference, keep a minimum distance of 5 meters (16.4 feet) between the soundbar and your Wi-Fi router.

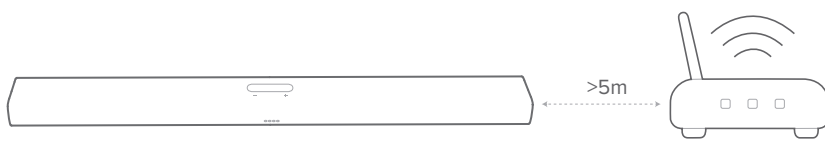

NOTE:

- Make sure that you have updated the HK Citation / Surround app to the latest version, and have enabled the Bluetooth and location service (iOS / Android).

/ SPEAKER SETUP (Optional)

Speaker Setup

You can wirelessly pair your CITATION BAR with:

- CITATION SUB (subwoofer, sold separately): to enhance the bass performance;
- CITATION SURROUND (satellite speakers, sold separately): to set up a 5.0 channel surround sound system.
- CITATION SUB and CITATION SURROUND: to set up a 5.1 channel surround sound system.



NOTES:

- For a successful setup, keep a maximum distance of 5 meters (16.4 feet) between the CITATION BAR and your CITATION SUB or CITATION SURROUND.
 - If the soundbar is powered off, the satellite speakers or subwoofer will enter standby mode.
 - If you use a device that uses the same frequency (2.4GHz or 5GHz) as the soundbar near your soundbar, interference may cause some sound interruption.
 - The maximum transmission distance of the wireless signal between the soundbar and satellite speakers or subwoofer may vary depending on your operating environment.
- 1) Power on your CITATION BAR, CITATION SUB, or / and CITATION SURROUND.
 - 2) Press **“Speaker Setup”** > **“Pairing”** > **“Surround Setup”** or **“Subwoofer Setup”** on the touch screen to enter pairing mode.
 - You will hear a pairing chime once successfully connected and **“Surround setup successful”** or **“Subwoofer connected”** will be displayed on the touch screen.
 - If no speakers are found, make sure to power on every speaker and retry the setup.

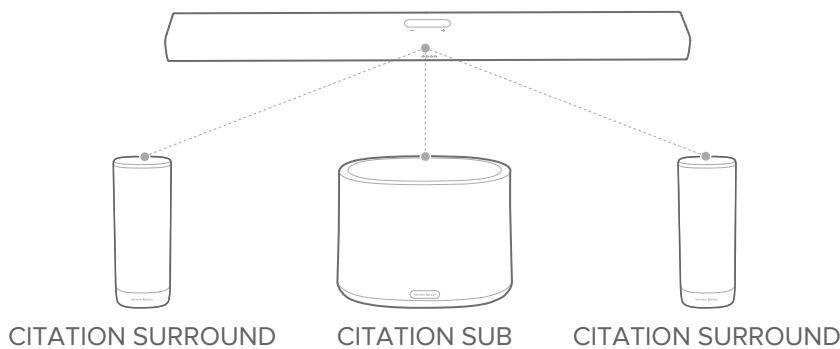
3) To remove the setup, press **“Surround Setup”** or **“Subwoofer pairing”** again, or reset the soundbar.



LED Indicator (CITATION SUB / CITATION SURROUND)

	White (Flashing)	<ul style="list-style-type: none"> • Pairing • Out of range / Lost wireless connection
	White (Constant for 10 seconds and then light off)	<ul style="list-style-type: none"> • Wirelessly connected with CITATION BAR

Test Tone

Press **“Speaker Setup”** > **“Levels”** > **“Test tone”** to play the test tone. Each speaker location icon will blink in sequence.

Speaker Volume and Bass

Press **“Speaker Setup”** > **“Levels”** > **“Speaker volume trim”** or **“Bass level trim”**, then swipe up / down to select speakers or adjust the volume and bass level.

USING YOUR CITATION BAR

Play Music

Stream QQ Music through Wi-Fi

NOTES:

- The Citation Bar can support audio streaming but not video streaming.
- Make sure that QPlay is enabled while streaming music via Wi-Fi.

- 1) Download and run the QQ Music app  on your smartphone or tablet.
- 2) Tap “设置” > “QPlay与车载音乐” > “音箱” > “开启” in the app to enable QPlay.
- 3) Start music playback.
- 4) On the player screen, tap ... and then the QPlay icon  to select “Citation Bar” as speaker.

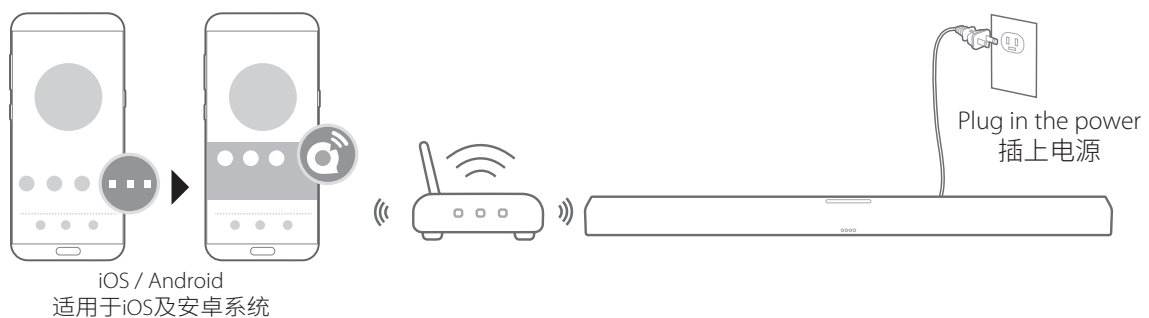

Multi-room Playback: Stream Music to Multiple Citation Speakers

- 1) Group Citation speakers:
 - a. On your smartphone or tablet, launch the HK Citation / Surround app;
 - b. Tap + to add more than one Citation speakers to the same home Wi-Fi network;

c. Tap + to set up a speaker group.

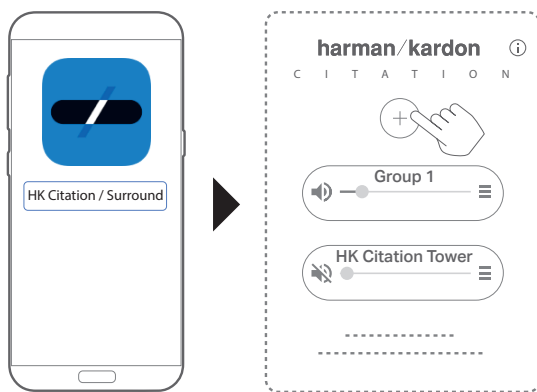

2) Multi-room playback:

Follow the steps under "Stream QQ Music through Wi-Fi" to select the grouped speakers.

3) To adjust the volume, do the following:

- a. Launch the HK Citation / Surround app;
- b. **Volume of a speaker group:** Tap to enter the player screen and drag the slider;
- c. **Volume of an individual speaker within the group:** On the player screen, tap to enter the speaker screen and drag the .

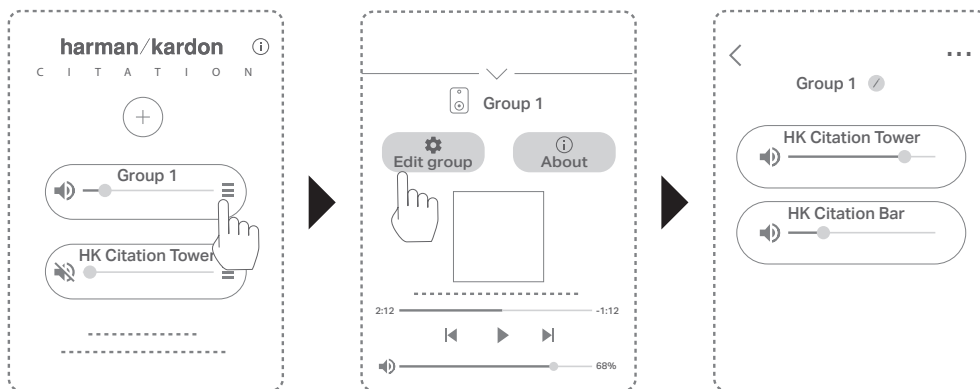

- 4) To edit the speaker group, do the following:
 - a. On the speaker screen, tap ... to edit the setup of the speaker group;
 - b. Tap **"Edit devices"** to add or remove a device;
Tap **"Ungroup"** to remove the speaker group.

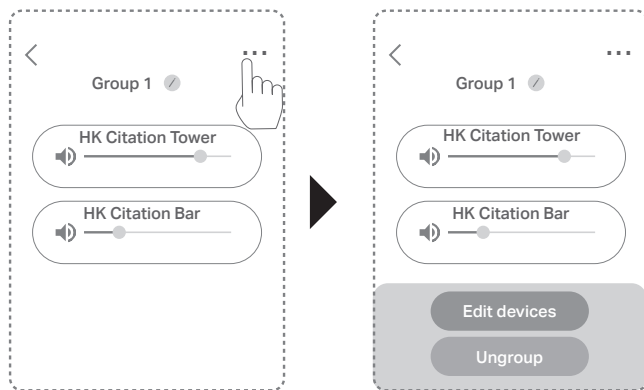

Stream Music through AirPlay



With AirPlay, you can stream music on your iOS device to the CITATION BAR.

- 1) Check that your iOS device has been connected to the same network as the soundbar.
- 2) To enter the Control Center on an iOS device, swipe down from the upper right corner (iOS 12 or later) or swipe up from the bottom edge (iOS 11 or earlier). Tap  to select the connected soundbar and then, start audio streaming from an app.



Play Music through Bluetooth



You can use your CITATION BAR as a speaker for your Bluetooth enabled smartphone or tablet.

- 1) Press  on the remote control or press  (**Bluetooth**) on the touch screen to enter Bluetooth pairing mode.
 - During the 10 seconds of connection period, or until a successful connection, the white circle below  icon will blink.
- 2) On your smartphone or tablet, select “**Citation Bar Speaker**” to connect. You will hear a pairing chime once connected.
 - When the music is playing, the track, title and artist of the song will be displayed on the touch screen.

NOTES:

- To exit the Bluetooth mode, choose other sources.
- To disconnect and pair another device, press  on the remote control or on the touch screen.
- The soundbar automatically turns off after 20 minutes of inactivity.
- Bluetooth performance can be affected by the distance between this product and your Bluetooth device and the environment of operation.
- Keep a maximum distance of 10 meters (33 feet) between this product and your Bluetooth device to avoid disconnection.

Playback Controls

- : Start, pause or resume play.
- : Skip to the previous/next track.

Talk to Voice Assistant

With the Tencent Xiaowei built-in, your CITATION BAR allows you to easily play music, check weather forecasts, set reminders and get answers through voice commands.

Set up Xiaowei

With the HK Citation / Surround app, do one of the following:

- During the first-time setup of CITATION BAR, follow the on-screen instructions; or
- Tap ⓘ and then, follow the on-screen instructions; or
- Tap ⓘ "About" and then, follow the on-screen instructions.

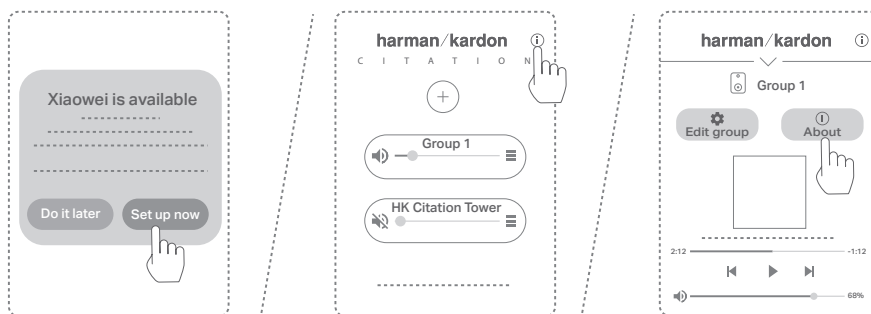

NOTE:

- Make sure that you have updated the HK Citation / Surround app to the latest version, and have enabled the Bluetooth and location service (iOS / Android).



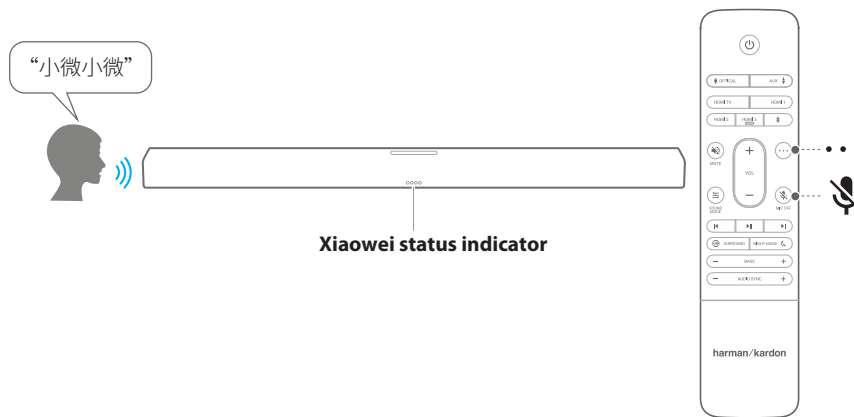

Use Xiaowei

- 1) Say the wake word **“Xiaowei Xiaowei”** to activate Xiaowei.
- 2) Speak out your voice commands.
 - To talk to Xiaowei without the wake word, push . . .

3) To stop Xiaowei from listening, press  to mute the microphone.



Xiaowei status indicator:

	Activated
	Listening
	Responding
	Microphone muted

NOTE:



- To learn more about the services, voice commands or usage provided by Xiaowei, refer to the relevant information in the WeChat Official Account of Xiaowei.

/ SOUND SETTINGS



Volume

You have three ways to adjust the volume level while playing music.

- Press or press and hold - / + button on the top panel.
- Softly drag the volume bar on the touch panel.
- Adjust the volume on your smartphone or tablet.

To mute the soundbar sound, press  **MUTE** on the remote control. To restore the sound, press  **MUTE** again or adjust the volume.

Sound Mode

Press  **SOUND MODE** on the remote control or press  **Audio** on the touch screen, then select predefined sound modes to suit your music or video.

- **Virtual Surround:** Creates surround sound effect (for a standalone soundbar).
- **Night Mode:** Decreases the volume of loud sounds. (Available only for Dolby Digital soundtracks)
- **Music Mode:** Creates stereo sound.
- **Movie Mode:** Creates a surround listening experience.
- **News Mode:** Makes human voice more clear.

Synchronize Video and Audio

If the audio and video are not synchronized, press **AUDIO SYNC +/-** on the remote control or press “**Speaker Setup**” > “**Lipsync delay**” on the touch screen.

/ SETTINGS

Display Brightness

Press **⚙️ (Options)** > **☀️ (Brightness)** to adjust the brightness of the touch screen.

Software Upgrade

The software of this product will be automatically upgraded to the latest version when it is connected to the Internet via a Wi-Fi network or Ethernet connection.

Restore Factory Settings

To restore the default settings programmed at the factory:

- Press **“Options”** > **“Factory Reset”** on the touch screen; or
- Press and hold the **RESET** button on the back of your CITATION BAR for 5 seconds.

When the factory settings restore is complete, this product will automatically power off and restart. Any stored information or settings will be erased.

System Information

Press **“System info”** on the touch screen to view the system information:

- **Country or region:** Country and language.
- **Network:** Network SSID, signal strength and Wi-Fi address.
- **About:** Model and name.
- **Software version:** Software version and date of last update.

Cleaning and Maintenance

Clean the wool fabric occasionally. Use an approved wool shampoo and follow the instructions carefully.

Many types of stain can be removed using warm water. If you act quickly, it is not difficult to remove a spill and avoid staining. Soak up the liquid with an absorbent napkin or cloth. For dried stains use a spoon to roughen the surface. To avoid the stain spreading further start from the edge of the stain working towards the middle.

CAUTION:

- To keep the exterior surface of your Citation speaker clean, unplug the AC power cord from the speaker first.
- Never use undiluted cleaning agents, bleaching agents, ammonia or soap intended for hard surfaces.
- In all cases, we recommend contacting a professional cleaning establishment, particularly for bigger stains and for thorough cleaning.

/ SPECIFICATIONS

- Transducer: 3 x 20mm tweeter, 6 x (100mm x 50mm) racetrack woofer
- Output power: 150W RMS
- Signal-to-noise ratio: >80dB
- Power Supply: 100-240V~50/60Hz
- Power consumption in sleep mode: <2.0 Watts
- Bluetooth® version: 4.2
- Bluetooth transmitter frequency range: 2402 – 2480MHz
- Bluetooth transmitter power: <10dBm
- Bluetooth transmitter modulation: GFSK, $\pi/4$ DQPSK, 8DPSK
- Wireless network: 802.11 a/b/g/n/ac (2.4GHz/5GHz)
- 2.4G Wi-Fi transmitter frequency range: 2412 – 2472MHz (2.4GHz ISM Band, USA 11 Channels, Europe and others 13 Channels)
- 2.4G Wi-Fi transmitter power: <20dBm
- 2.4G Wi-Fi modulation: DBPSK, DQPSK, CCK, QPSK, BPSK, 16QAM, 64QAM
- 5G Wi-Fi transmitter power: <23dBm
- 5G Wi-Fi modulation: QPSK, BPSK, 16QAM, 64QAM, 256QAM
- 5G Wi-Fi transmitter frequency range: 5.15 - 5.35GHz, 5.725 - 5.825GHz
- 5G WISA transmitter power: < 14dBm
- 5G WISA modulation: OFDM, BPSK, QPSK, 16QAM
- 5G WISA transmitter frequency range: 5.15-5.35GHz, 5.725-5.825GHz
- Dimensions (W x H x D): 1150 x 62 x 115mm
- Weight: 4.18 kg
- Packaging Dimensions (W x H x D): 1224 x 176 x 180 mm
- Packaging Weight (Gross): 6.32 kg

/ TROUBLESHOOTING

Sound

No sound from the soundbar.

- Make sure that the soundbar is not muted.
- Make sure to select the correct audio input source.

No sound from CITATION SUB or CITATION SURROUND.

- Check if the subwoofer or the satellite speakers LED is in solid white color. Blinking LED means a disconnection. Manually pair them with the soundbar.
- Play the test tone (See Section “**Test Tone**”).

Distorted sound or echo.

- If you play audio from the TV through the soundbar, make sure the TV is muted or the built-in TV speaker is disabled.

Audio and video are not synchronized.

- Press **AUDIO SYNC +/-** to synchronize.

Bluetooth

A device cannot connect with the soundbar.

- Check if you enable the Bluetooth function of the device.
- The soundbar is already connected to another Bluetooth device. Press **✕** on the remote control to disconnect and pair with a new device.

Poor audio quality from a connected Bluetooth device.

- The Bluetooth reception is poor. Move the device closer to the soundbar, or remove any obstacle between the device and the soundbar.

Wi-Fi

Failed to connect to Wi-Fi.

- Make sure that Wi-Fi is turned on.
- Make sure that you have selected the right network and entered the correct password.
- Make sure that your router or modem is turned on and within the range.
- Make sure that your CITATION is connected to the same wireless network as your smartphone or tablet.

The HK Citation / Surround app cannot find the device.

- Make sure that your CITATION is powered on.
- Make sure that your network is working properly.
- Make sure that your router or modem is powered on and within the range.

/ TRADEMARKS



The Bluetooth® word mark and logos are registered trademarks owned by the Bluetooth SIG, Inc. and any use of such marks by HARMAN International Industries, Incorporated is under license. Other trademarks and trade names are those of their respective owners.



The Wi-Fi CERTIFIED wLogo is a certification mark of the Wi-Fi Alliance.



Manufactured under license from Dolby Laboratories. Dolby, Dolby Audio, Pro Logic and the double-D symbol are trademarks of Dolby Laboratories.



The terms HDMI, HDMI High-Definition Multimedia Interface, and the HDMI logo are trademarks or registered trademarks of HDMI Licensing Administrator, Inc.

腾讯小微、QQ音乐是本音响的内容合作伙伴腾讯公司的商业标识或版权形象。

harman / kardon[®]
by HARMAN